

P 6215

WEATHERPROOF COAXIAL TWO-WAY SPEAKER

DESCRIPTION

The P 6215 is a weatherproof full range, wide-dispersion, coaxial two-way loudspeaker system for very high output and long-throw applications. The speaker can be installed individually or coupled in array configurations. The low-frequency transducer is a 15" neodymium woofer, the high-frequency section combines a 1.3" neodymium RCF Precision compression driver with a 2.5" diaphragm assembly centrally mounted in the throat of the LF driver and loaded on a constant directivity CMD horn for smooth, wide dispersion. Internal circuit provides low crossover frequency for accurate vocal intelligibility and Active Mosfet Compression Driver Protection (AMCDP). The single-piece roto-molded cabinet is fully UV protected and meets IP-55 standard requirements, equipped with M10 brass inserts (12x), and one durable and corrosion-resistant 316P stainless steel U-Bracket with f spacers (2x) for 90° mounting. The aluminum grille cover is powder coated with water-repellent backing material and has a rotatable logo plate.



FEATURES

- 134 dB SPL Max, 600W RMS
- Weatherproof IP55 cabinet with UV protection
- Rotomoulded cabinet available in white or black
- 60° x 60° conical CMD horn
- One 15" high-output neodymium LF transducer
- One RCF Precision 2.5" neodymium C. Driver
- Active Mosfet Compression Driver Protection
- 12 brass suspension points (M10)

TECHNICAL SPECIFICATIONS

Acoustical specifications	Frequency Response (-10dB):	75 Hz ÷ 20000 Hz
	Max SPL @ 1m:	134 dB
	Horizontal coverage angle:	60°
	Vertical coverage angle:	60°
	Directivity index Q:	13
	System Sensitivity:	100 dB
Power section	Nominal Impedance:	8 ohm
	Power Handling:	600 W RMS
	Peak Power Handling:	2400 W PEAK
	Recommended Amplifier:	1200 W
	Protections:	Dynamic active mosfet
	Crossover Frequencies:	1100 Hz
Transducers	Compression Driver:	Coaxial 1.3" neo, 2.5" v.c
	Nominal Impedance:	8 ohm
	Input Power Rating:	90 W AES, 180 W PROGRAM POWER
	Sensitivity:	108 dB, 1W @ 1m
	Woofer:	Coaxial 15" neo, 3.0" v.c
	Nominal Impedance:	8 ohm
	Input Power Rating:	450 W AES, 900 W PROGRAM POWER
	Sensitivity:	101 dB, 1W @ 1m
Input/Output section	Input connectors:	Neoprene Cable
Standard compliance	IP protection grade:	IP 55
	CE marking:	Yes
Physical specifications	Cabinet/Case Material:	PE Low Density
	Hardware:	12 x M10 + U-Bracket and Pair of spacers
	Grille:	Aluminum with waterproof clothing
	Color:	Grey
Size	Height:	463 mm / 18.23 inches
	Width:	463 mm / 18.23 inches
	Depth:	433 mm / 17.05 inches
	Weight:	17 kg / 37.48 lbs
Shipping informations	Package Height:	519 mm / 20.43 inches
	Package Width:	489 mm / 19.25 inches
	Package Depth:	489 mm / 19.25 inches
	Package Weight:	21.4 kg / 47.18 lbs



PART NUMBER

- **13100083**

P 6215 W

EAN 8024530017521

- **13000131**

P 6215

EAN 8024530008260

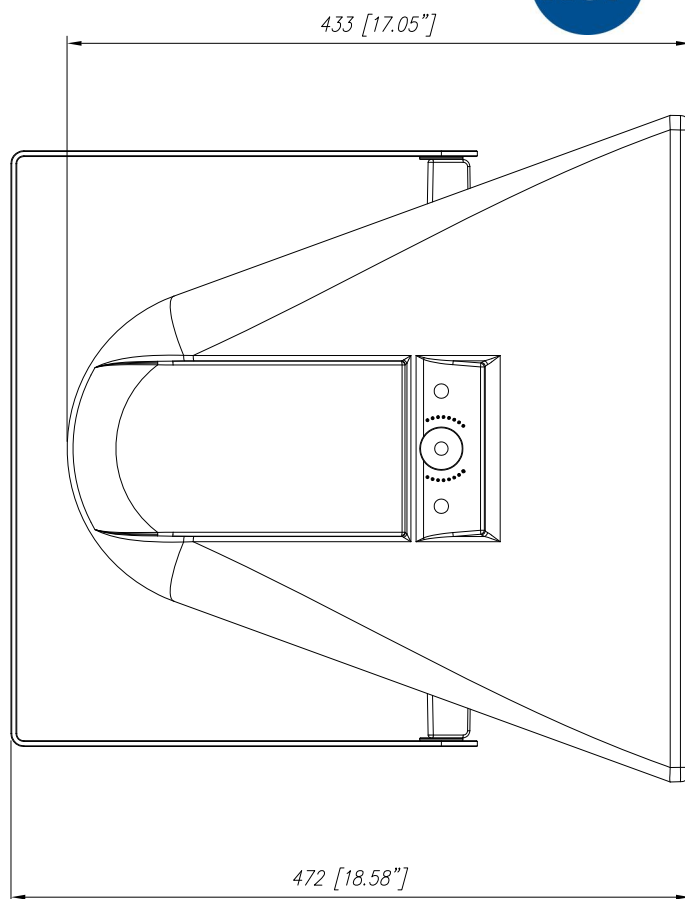
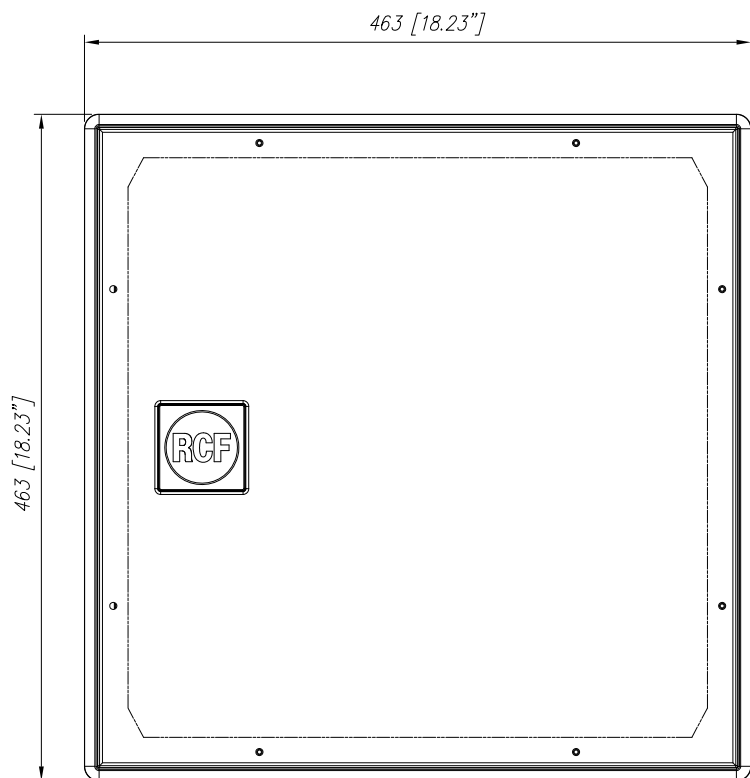

P3115

P6215

P8015

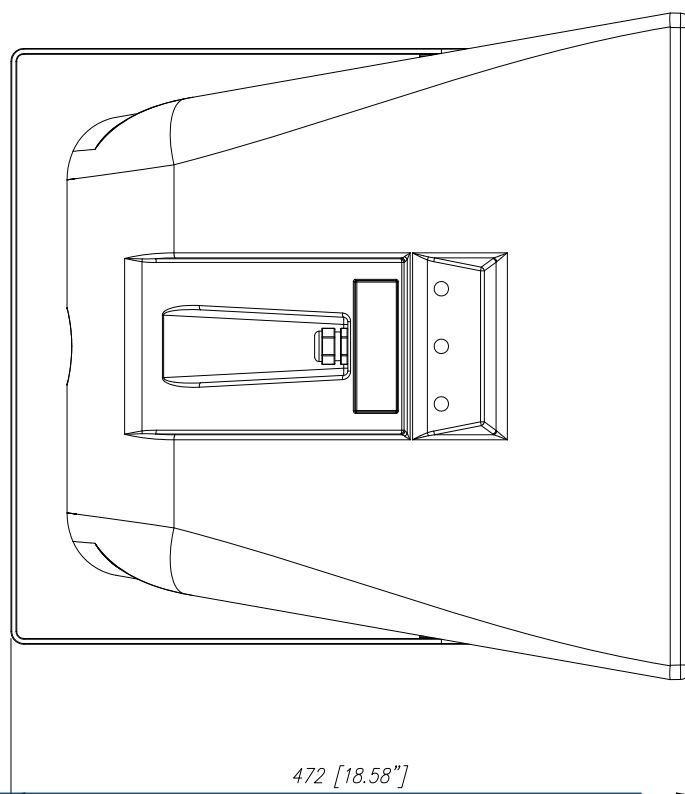

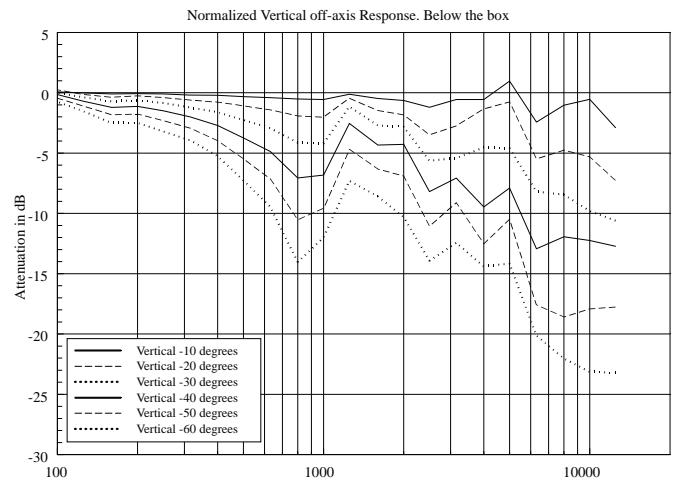
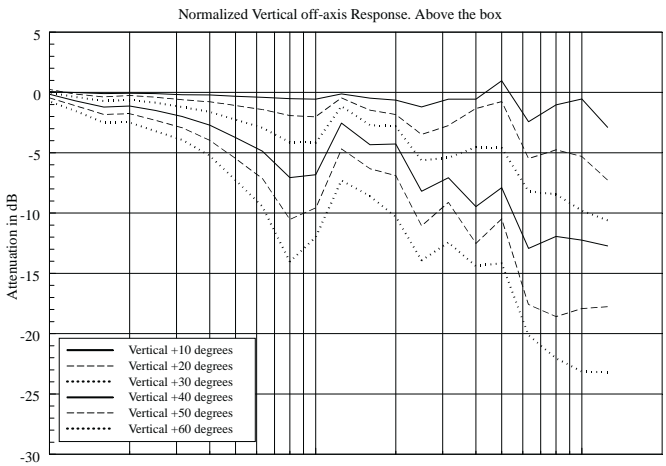
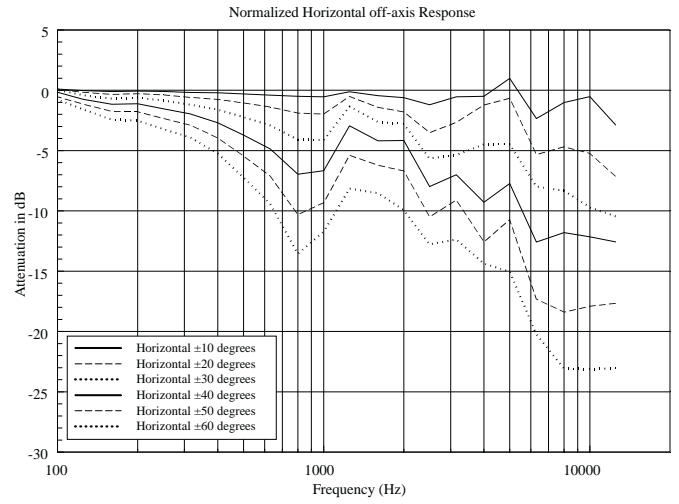
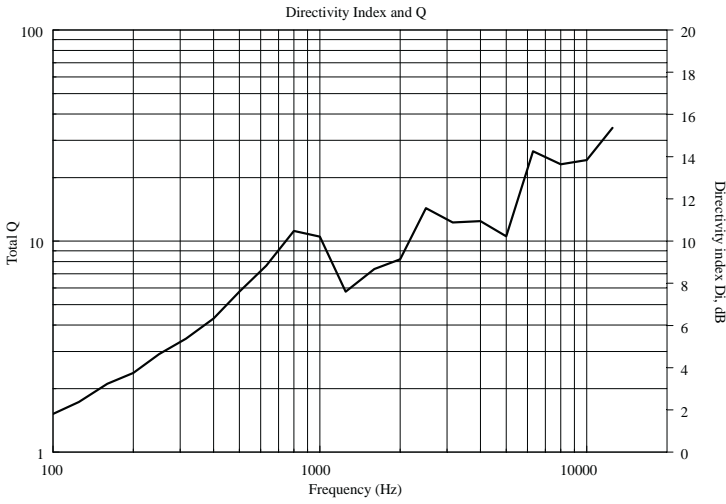
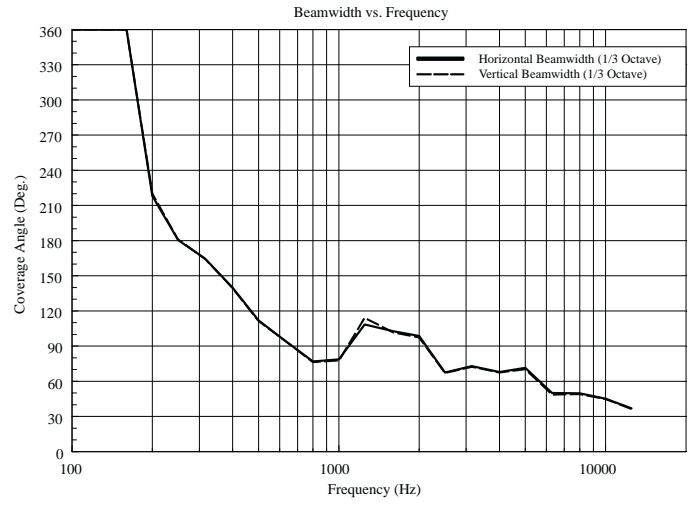
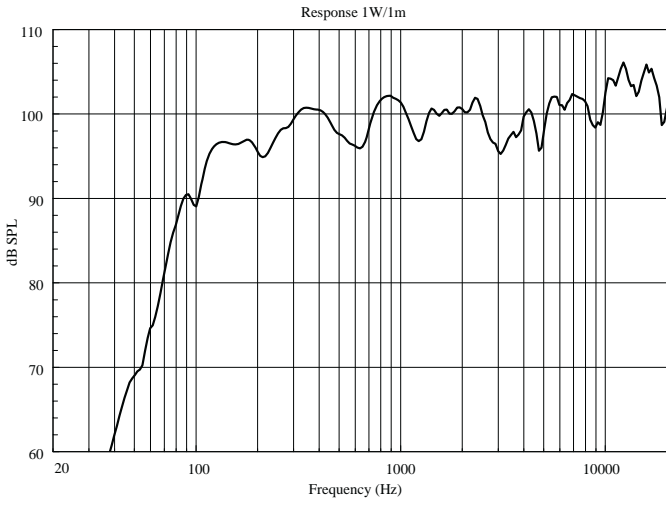

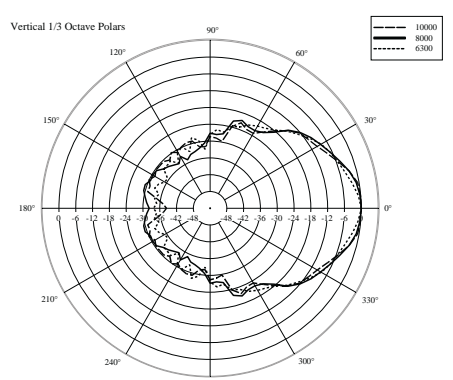
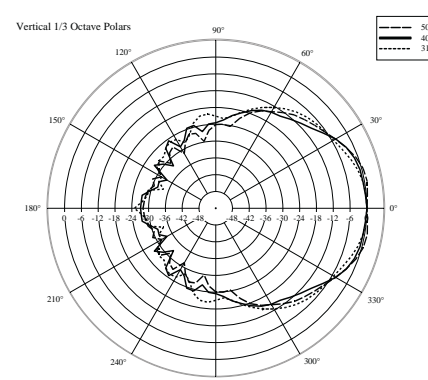
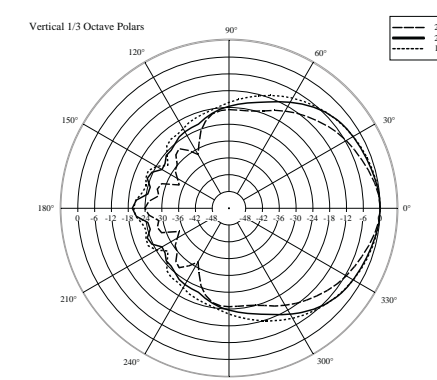
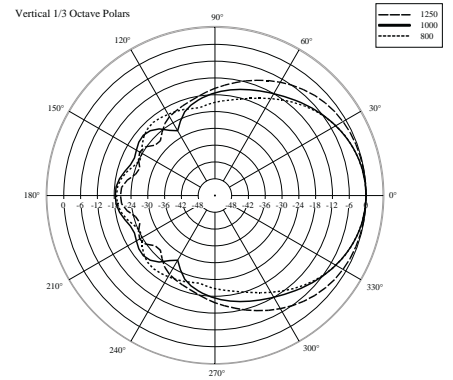
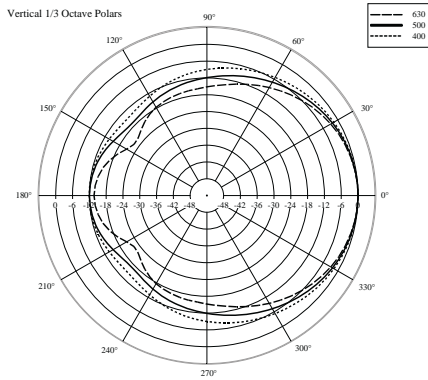
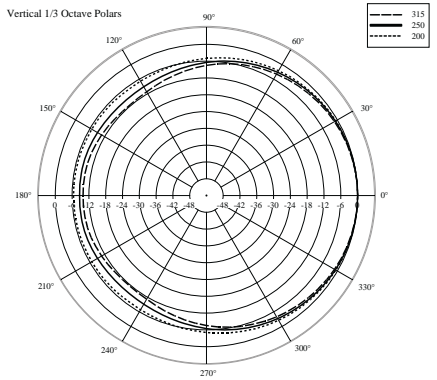
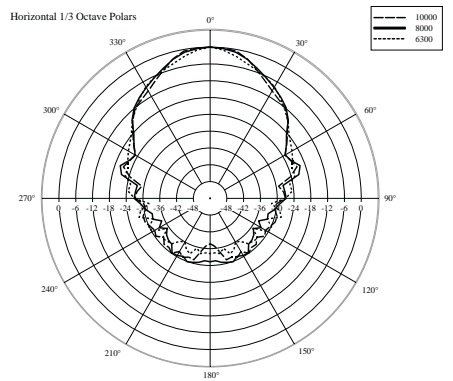
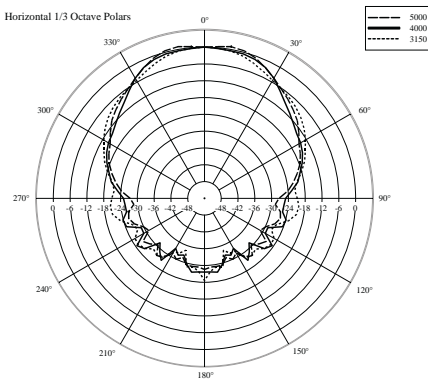
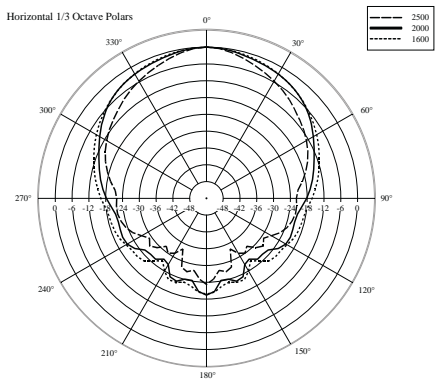
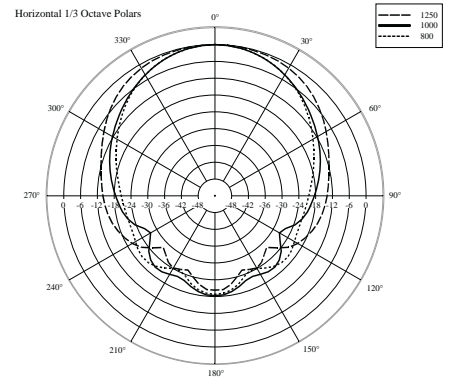
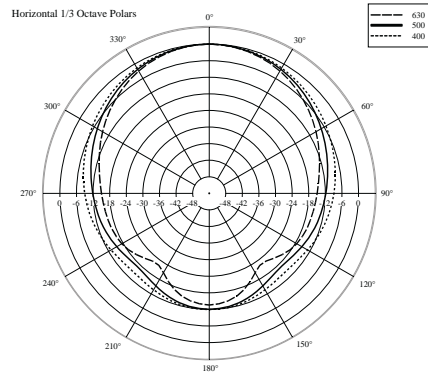
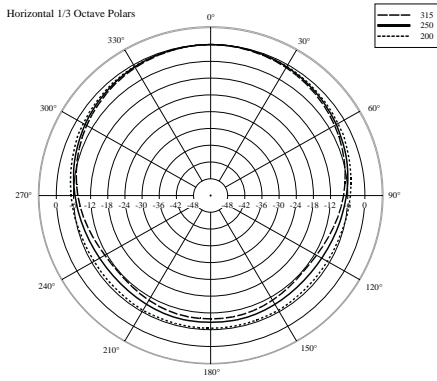

ACCESSORIES



AC P15 A-BR CLUSTER BRACK.- P6215/P3115

PART NUMBER

13360094

EAN:

8024530006105
