

P 3115T

WEATHERPROOF COAXIAL TWO WAY SPEAKER

DESCRIPTION

The P 3115T is a weatherproof full range, wide-dispersion, coaxial two-way loudspeaker system for a variety of professional indoor or outdoor applications. The speaker can be installed individually or coupled in array configurations. The low-frequency transducer is a 15" woofer with a 3" voice coil. The high-frequency section combines a 1.3" RCF Precision compression driver with a 2.5" diaphragm assembly centrally mounted in the throat of the LF driver and loaded on a constant directivity CMD horn for smooth, wide dispersion. The P3115-T features a selectable line transformer for 70 - 100 volt applications, built-in LICC crossover, and Active Mosfet Compression Driver Protection (AMCDP). The single-piece roto-molded cabinet is fully UV protected and meets IP-55 standard requirements, equipped with M10 brass inserts (12x), and a durable and corrosion-resistant 316P stainless steel U-Bracket with spacers (2x) for 90° mounting. The aluminum grille cover is powder coated with water-repellent backing material and has a rotatable logo plate.



FEATURES

- Cabinet is a single piece rotational moulded in medium density polyethylene, fully UV protected and waterproof IP 55
- Front grille in custom perforated aluminium with open-cell fibres and water repellent woven fabric backing
- Stainless steel bracket
- 15" high-output LF transducer with 2.5" voice coil
- RCF Precision 1" Compression Driver with 1.5" voice coil
- 90° x 60° constant directivity horn
- 10° X 20° enclosure sides for array configurations
- Active Mosfet Compression Driver Protection
- 12 brass suspension points (M10)
- Line transformer

TECHNICAL SPECIFICATIONS

Acoustical specifications	Frequency Response (-10dB):	75 Hz ÷ 20000 Hz
	Max SPL @ 1m:	129 dB
	Horizontal coverage angle:	90°
	Vertical coverage angle:	60°
	Directivity index Q:	13
	System Sensitivity:	98 dB
Power section	Nominal Impedance:	16 ohm
	Power Handling:	300 W RMS
	Peak Power Handling:	1200 W PEAK
	Recommended Amplifier:	600 W
	Protections:	Dynamic active mosfet
	Crossover Frequencies:	1300 Hz
Transducers	Compression Driver:	1.0", 1.5" v.c
	Nominal Impedance:	8 ohm
	Input Power Rating:	25 W AES, 50 W PROGRAM POWER
	Sensitivity:	108 dB, 1W @ 1m
	Woofer:	Coaxial 15", 2.5" v.c
	Nominal Impedance:	16 ohm
	Input Power Rating:	250 W AES, 500 W PROGRAM POWER
	Sensitivity:	98 dB, 1W @ 1m
Input/Output section	Input connectors:	Neoprene Cable
	Constant Voltage Transformer:	100 V
	Power selection 1:	120 W - 83 ohm
	Power selection 2:	60 W - 167 ohm
	Power selection 3:	30 W - 333 ohm
Standard compliance	IP protection grade:	IP 55
	CE marking:	Yes
Physical specifications	Cabinet/Case Material:	PE Low Density
	Hardware:	12 x M10 inserts + U-brackets and pair of spacers
	Grille:	Aluminum with waterproof clothing
	Color:	Grey
Size	Height:	463 mm / 18.23 inches
	Width:	463 mm / 18.23 inches
	Depth:	433 mm / 17.05 inches
	Weight:	18.4 kg / 40.57 lbs
Shipping informations	Package Height:	530 mm / 20.87 inches
	Package Width:	490 mm / 19.29 inches
	Package Depth:	490 mm / 19.29 inches
	Package Weight:	23.2 kg / 51.15 lbs



PART NUMBER

- **13100082**

P 3115T W

EAN 8024530017514

- **13000135**

P 3115T

EAN 8024530008307

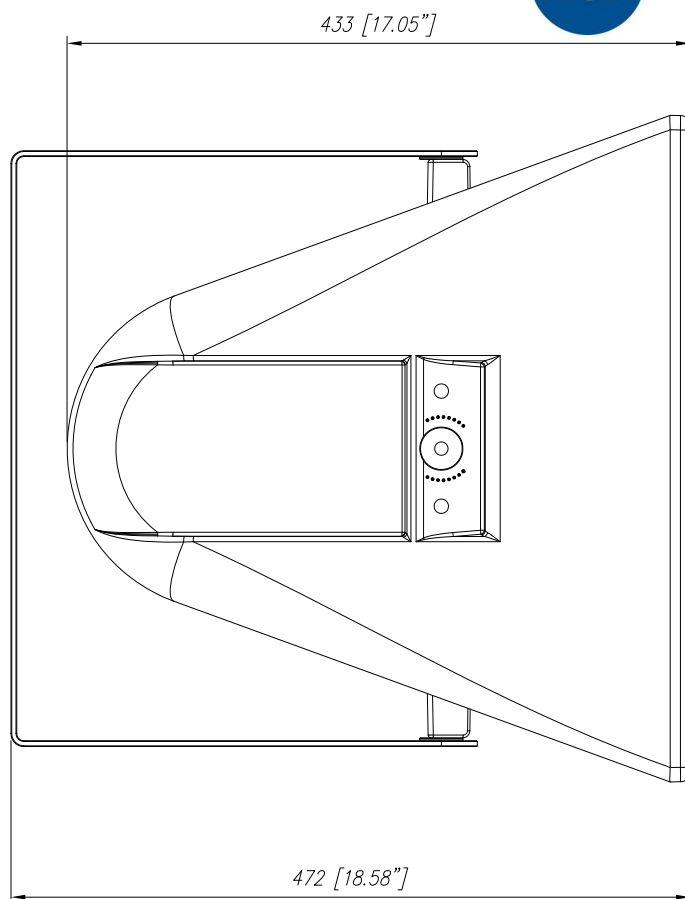
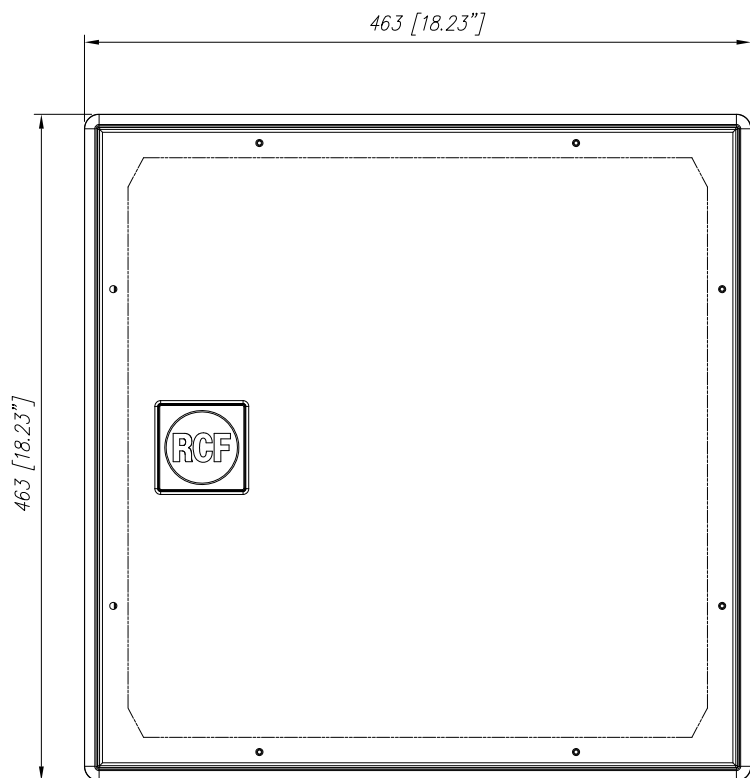

P3115

P6215

P8015

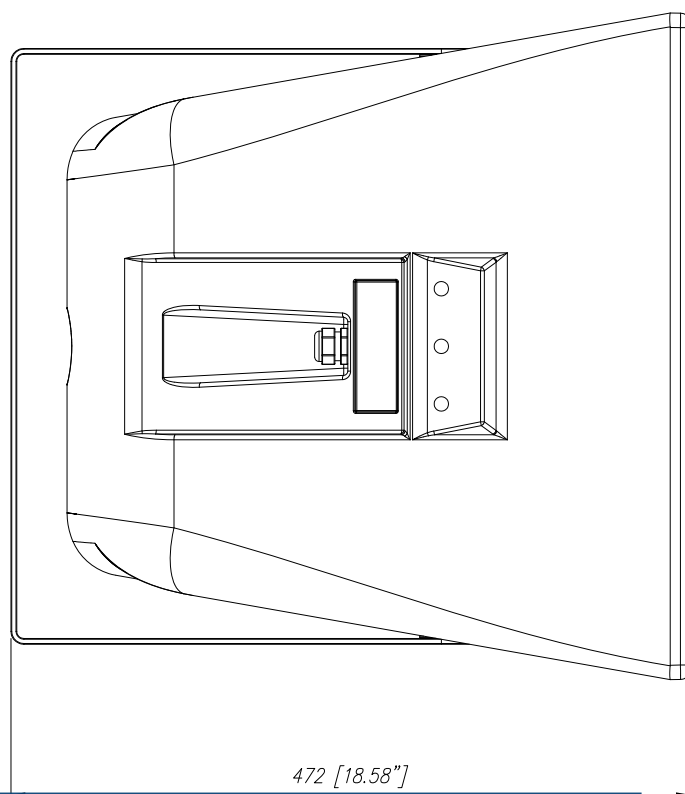

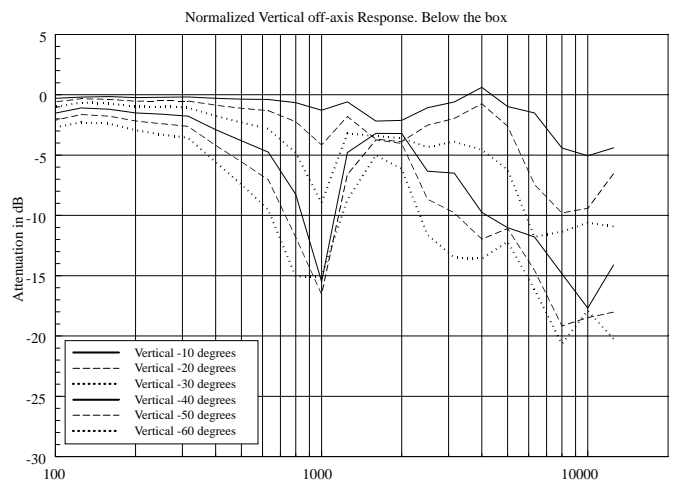
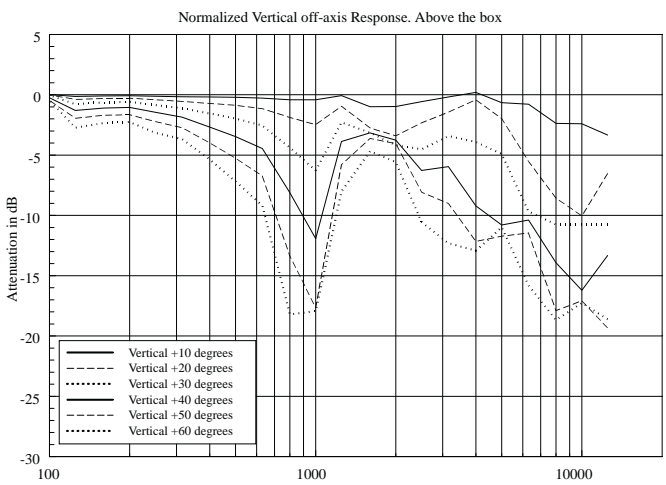
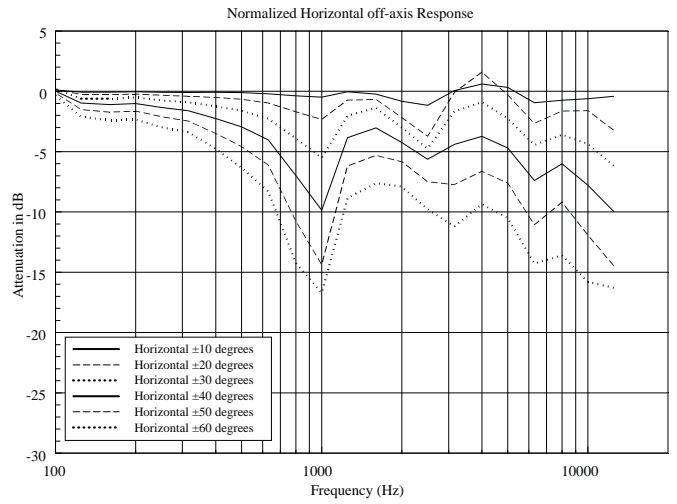
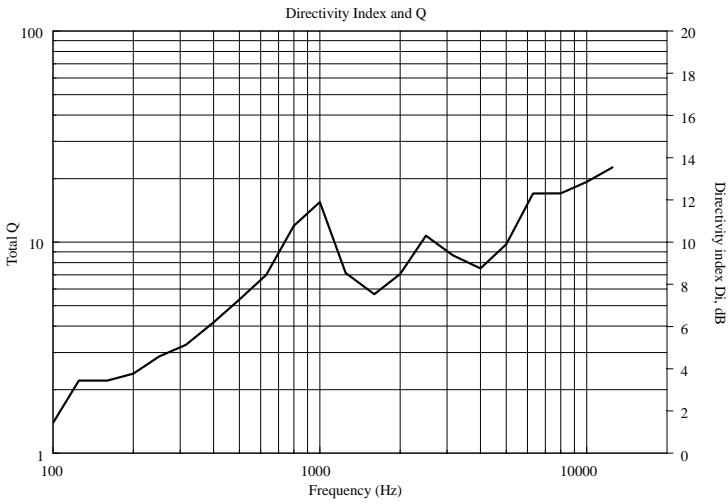
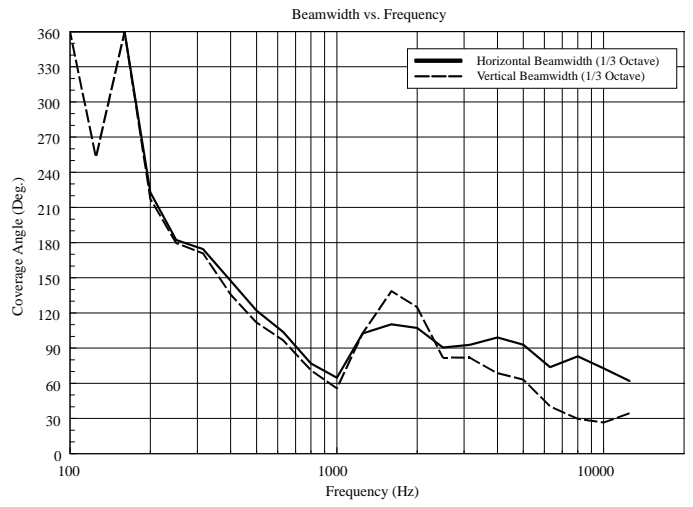
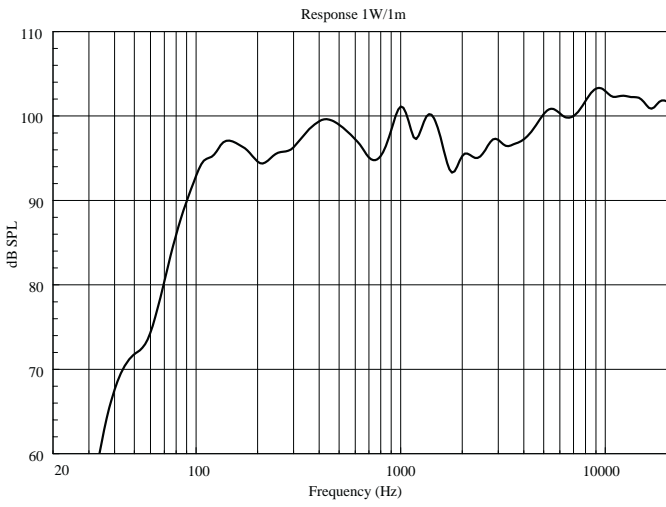

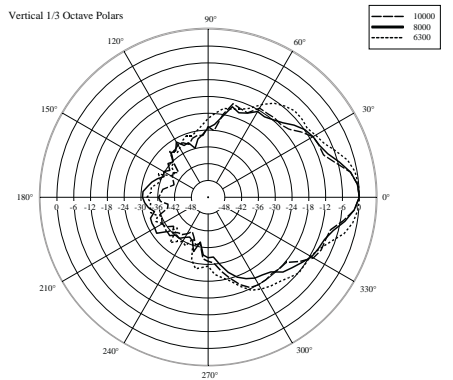
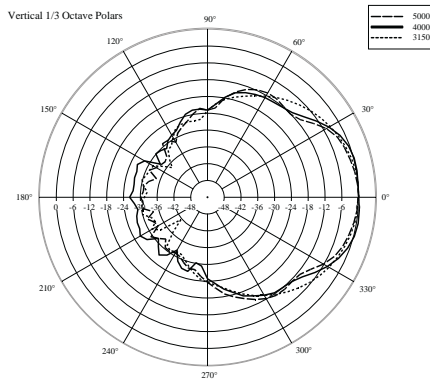
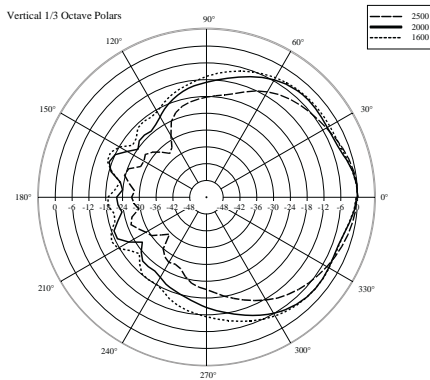
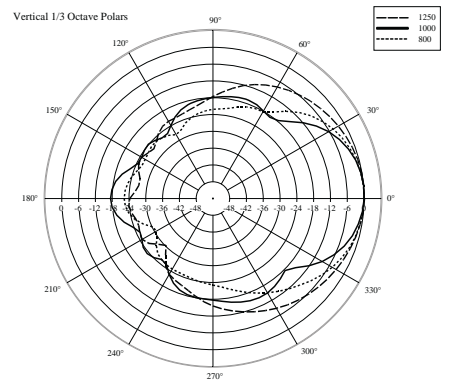
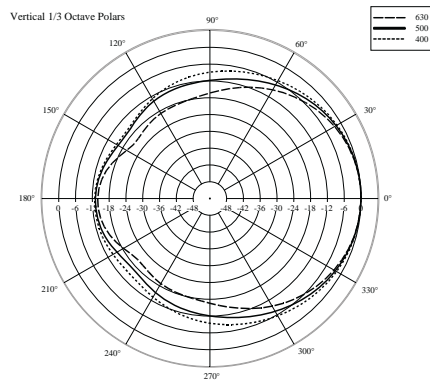
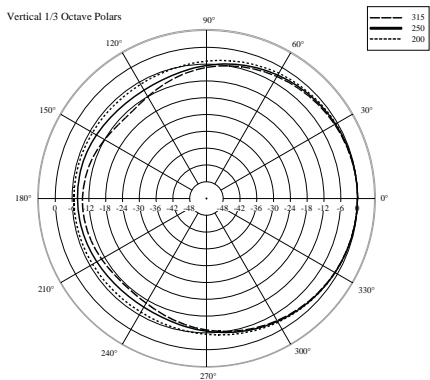
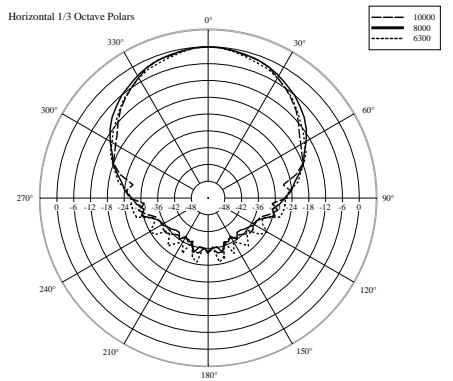
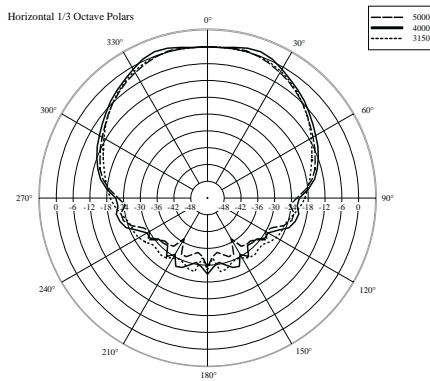
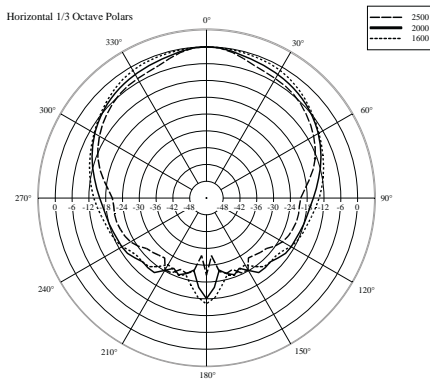
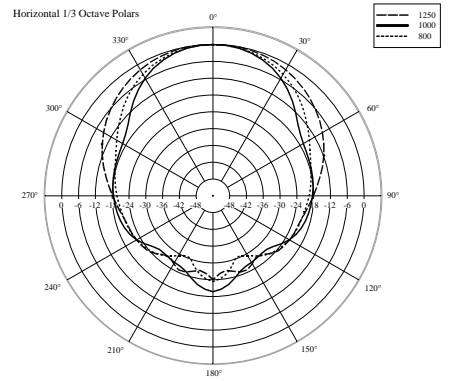
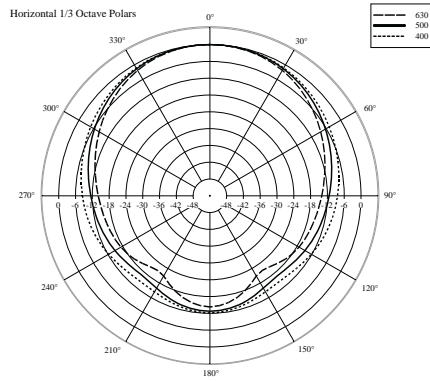
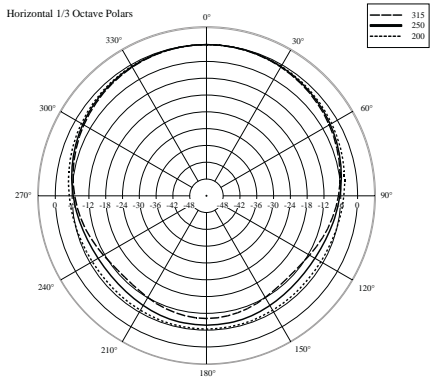

ACCESSORIES



AC P15 A-BR CLUSTER BRACK.- P6215/P3115

PART NUMBER

13360094

EAN:

8024530006105
