

P 2110T

WEATHERPROOF COAXIAL TWO-WAY SPEAKER

DESCRIPTION

The P 2110T is a weatherproof full-range, wide-dispersion, coaxial two-way loudspeaker system for a variety of professional indoor or outdoor applications. The speaker can be installed individually or coupled in array configurations. The low-frequency transducer is a 10" woofer with a 2.5" voice coil. The high-frequency section combines a 1" RCF Precision compression driver with a 1.5" diaphragm assembly centrally-mounted in the throat of the LF driver, and loaded on a constant directivity CMD horn for smooth, wide dispersion. The P 2110T features a selectable line transformer for 70 - 100 volt applications, built-in LICC crossover, and Active Mosfet Compression Driver Protection (AMCDP). The single-piece roto-molded cabinet is fully UV protected and meets IP-55 standard requirements. Included are M10 brass inserts (12 x) and one durable corrosion-resistant 316P stainless steel U-Bracket with spacers (2x) for 90° mounting. The aluminum grille cover is powder coated with water-repellent backing material and a rotatable logo plate.



FEATURES

- 124 dB SPL Max, 200W RMS
- Weatherproof IP55 cabinet with UV protection
- Line transformer
- 90° x 40° CMD constant directivity horn
- 10" high-output LF transducer with 2.5" voice coil
- RCF Precision 1" C. Driver with 1.5" voice coil
- 12 brass suspension points (M10)
- Roto-moulded single piece cabinet

TECHNICAL SPECIFICATIONS

Acoustical specifications	Frequency Response (-10dB):	95 Hz ÷ 20000 Hz
	Max SPL @ 1m:	124 dB
	Horizontal coverage angle:	90°
	Vertical coverage angle:	40°
	Directivity index Q:	11
	System Sensitivity:	95 dB
Power section	Nominal Impedance:	16 ohm
	Power Handling:	200 W RMS
	Peak Power Handling:	800 W PEAK
	Recommended Amplifier:	400 W
	Protections:	Dynamic active mosfet
	Crossover Frequencies:	2000 Hz
Transducers	Compression Driver:	1.0", 1.5" v.c
	Nominal Impedance:	8 ohm
	Input Power Rating:	25 W AES, 50 W PROGRAM POWER
	Sensitivity:	106 dB, 1W @ 1m
	Woofers:	Coaxial 10", 2.5" v.c
	Nominal Impedance:	16 ohm
	Input Power Rating:	180 W AES, 360 W PROGRAM POWER
Sensitivity:	95 dB, 1W @ 1m	
Input/Output section	Input connectors:	Neoprene Cable
	Constant Voltage Transformer:	100 V
	Power selection 1:	60 W - 167 ohm
	Power selection 2:	30 W - 333 ohm
	Power selection 3:	15 W - 667 ohm
Standard compliance	IP protection grade:	IP 55
	CE marking:	Yes
Physical specifications	Cabinet/Case Material:	PE Low Density
	Hardware:	12 x M8 inserts + U-brackets and pair of spacers
	Grille:	Aluminum with waterproof clothing
	Color:	Grey
Size	Height:	350 mm / 13.78 inches
	Width:	350 mm / 13.78 inches
	Depth:	320 mm / 12.6 inches
	Weight:	13.4 kg / 29.54 lbs
Shipping informations	Package Height:	400 mm / 15.75 inches
	Package Width:	370 mm / 14.57 inches
	Package Depth:	370 mm / 14.57 inches
	Package Weight:	16.3 kg / 35.94 lbs



PART NUMBER

- **13000125**

P 2110T

EAN 8024530008246

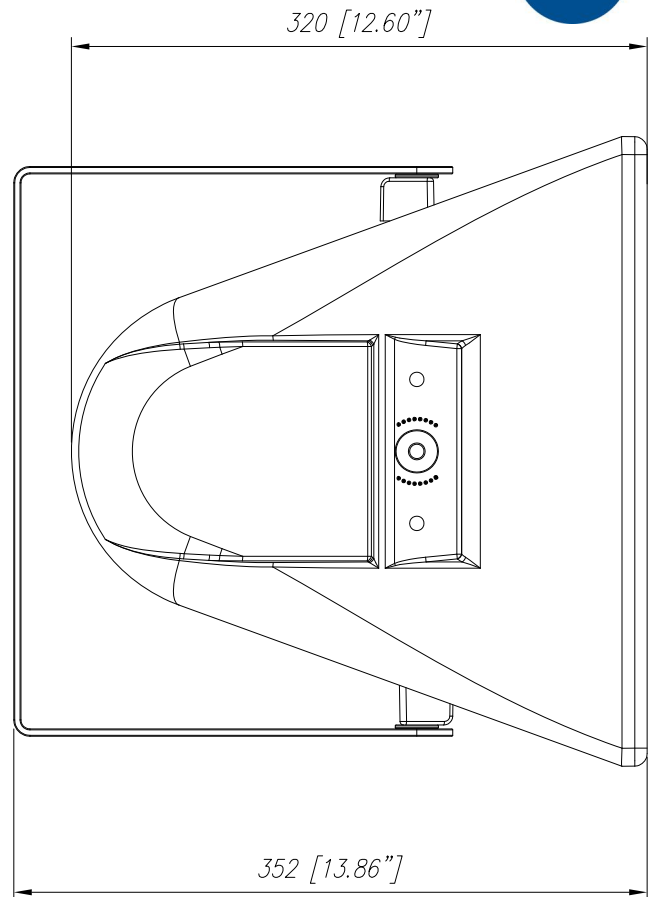
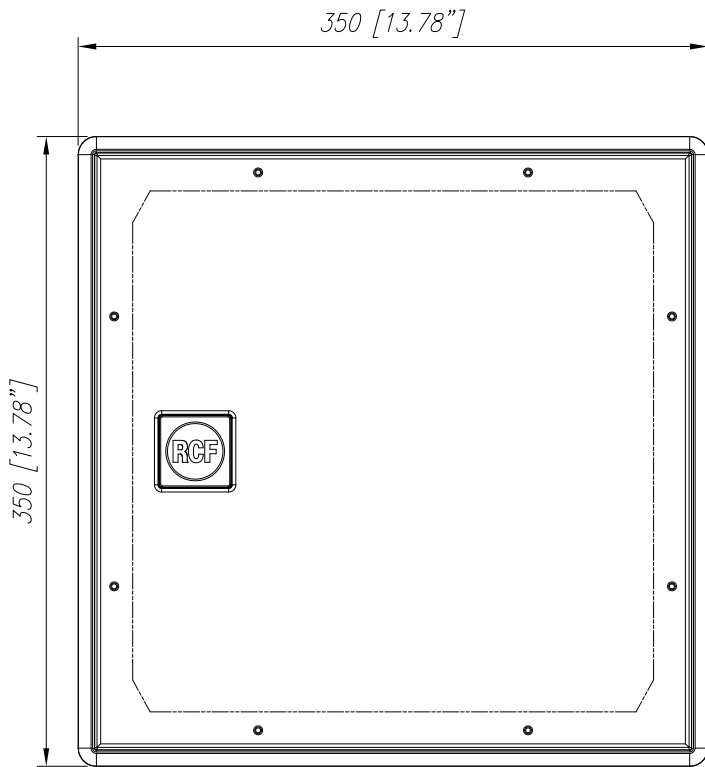

P2110

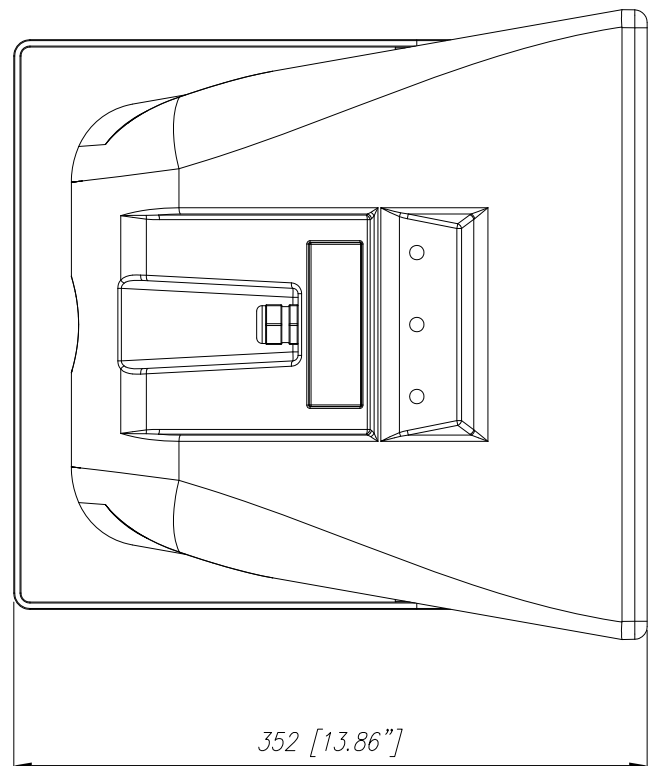

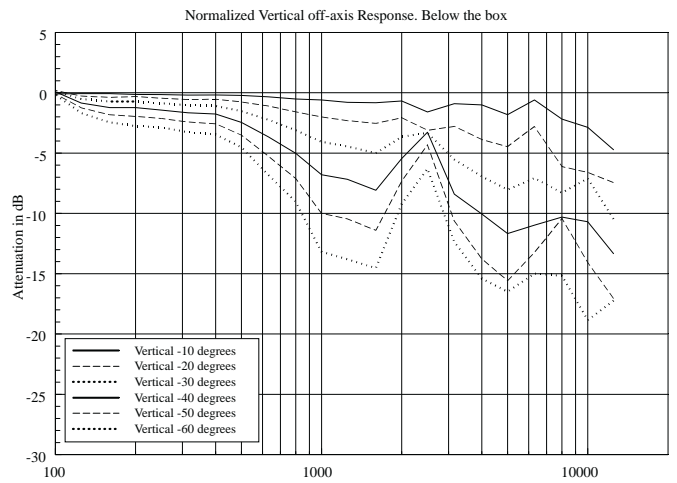
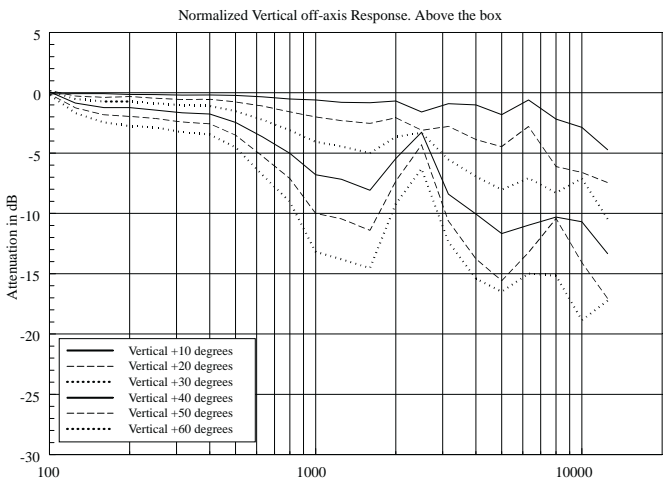
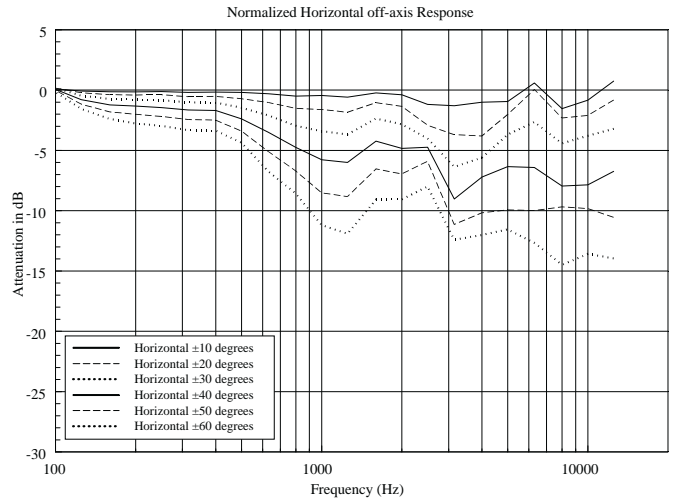
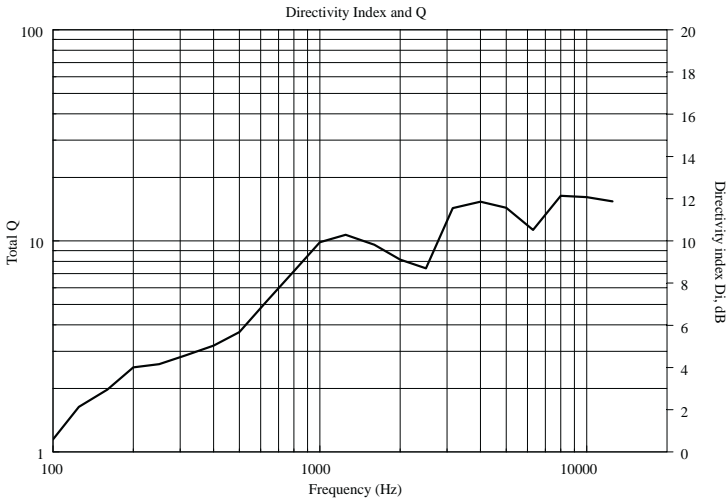
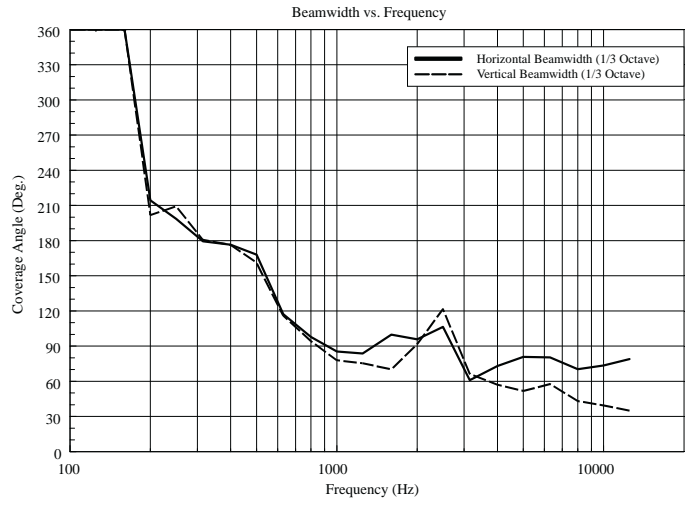
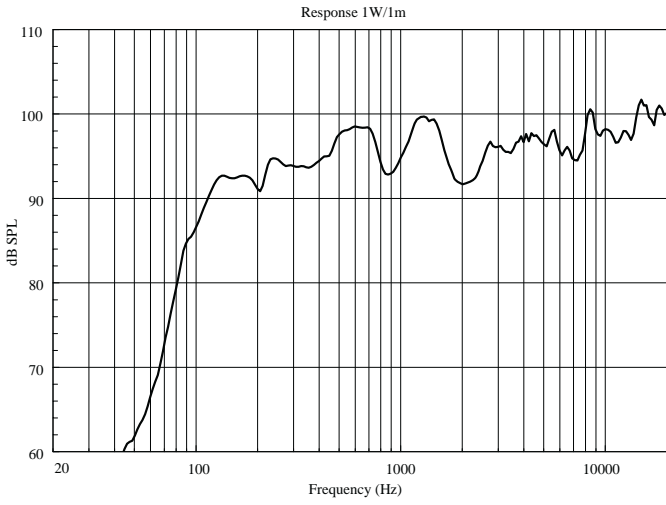

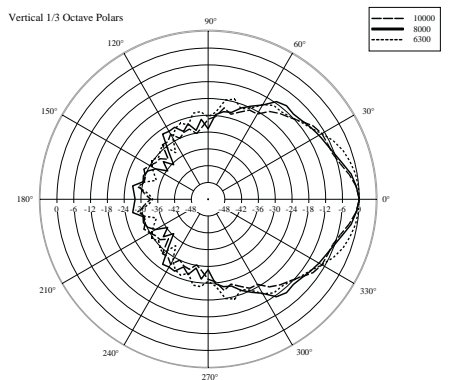
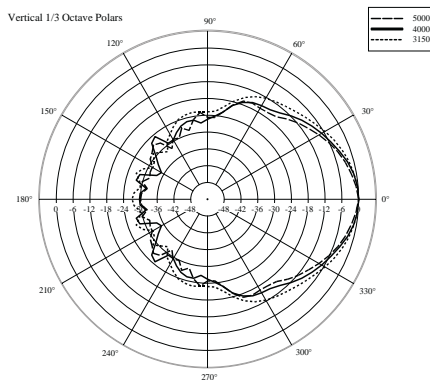
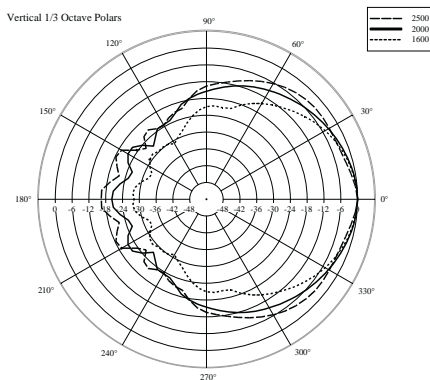
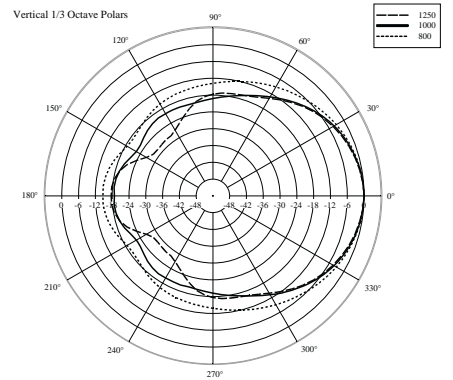
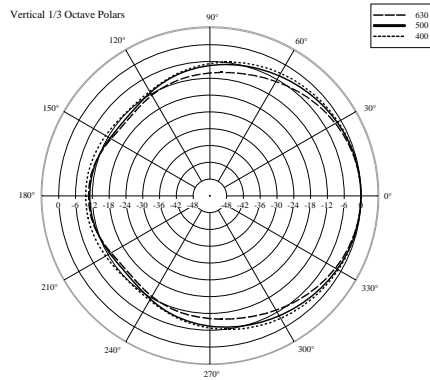
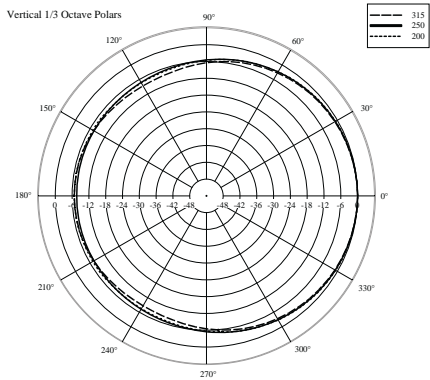
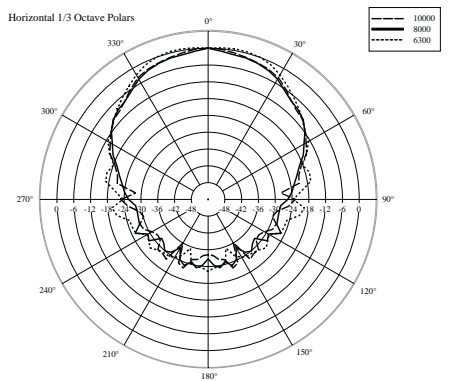
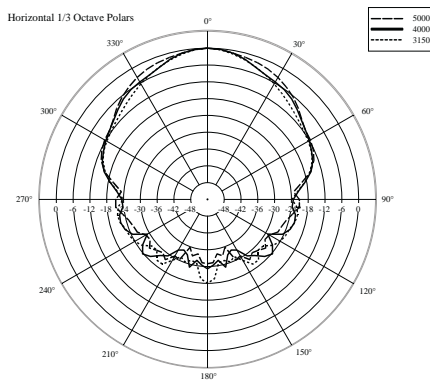
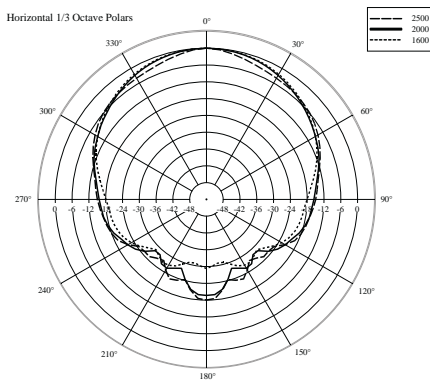
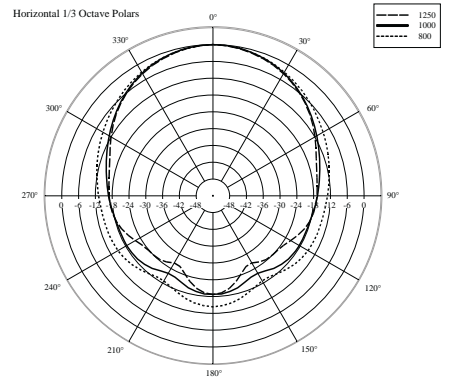
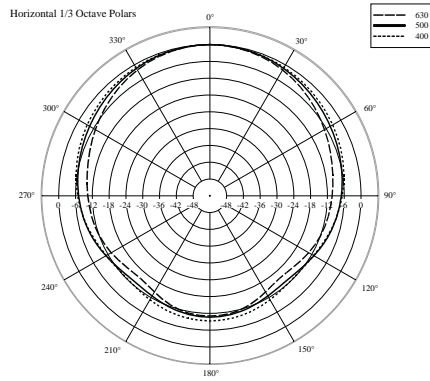
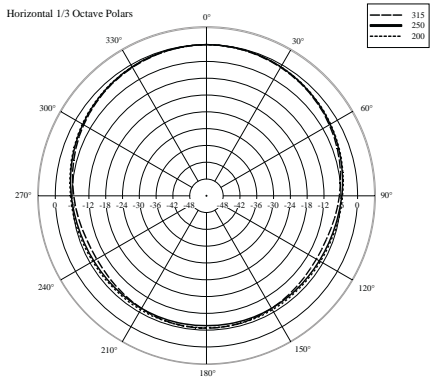



ACCESSORIES